

Rev.	design change reason	Date	Name
Ver 1.0	Release	2013/08/29	Nancy

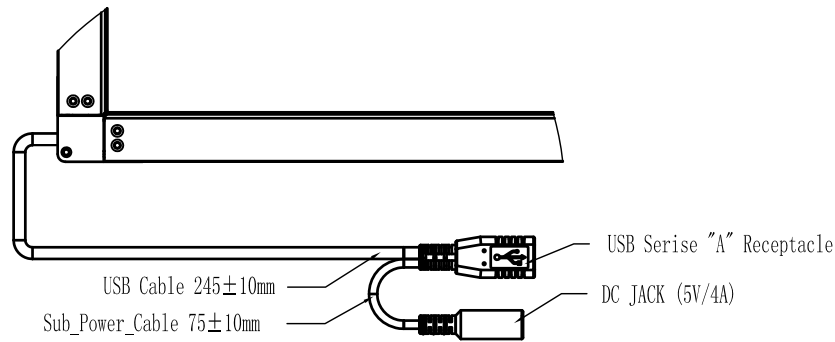
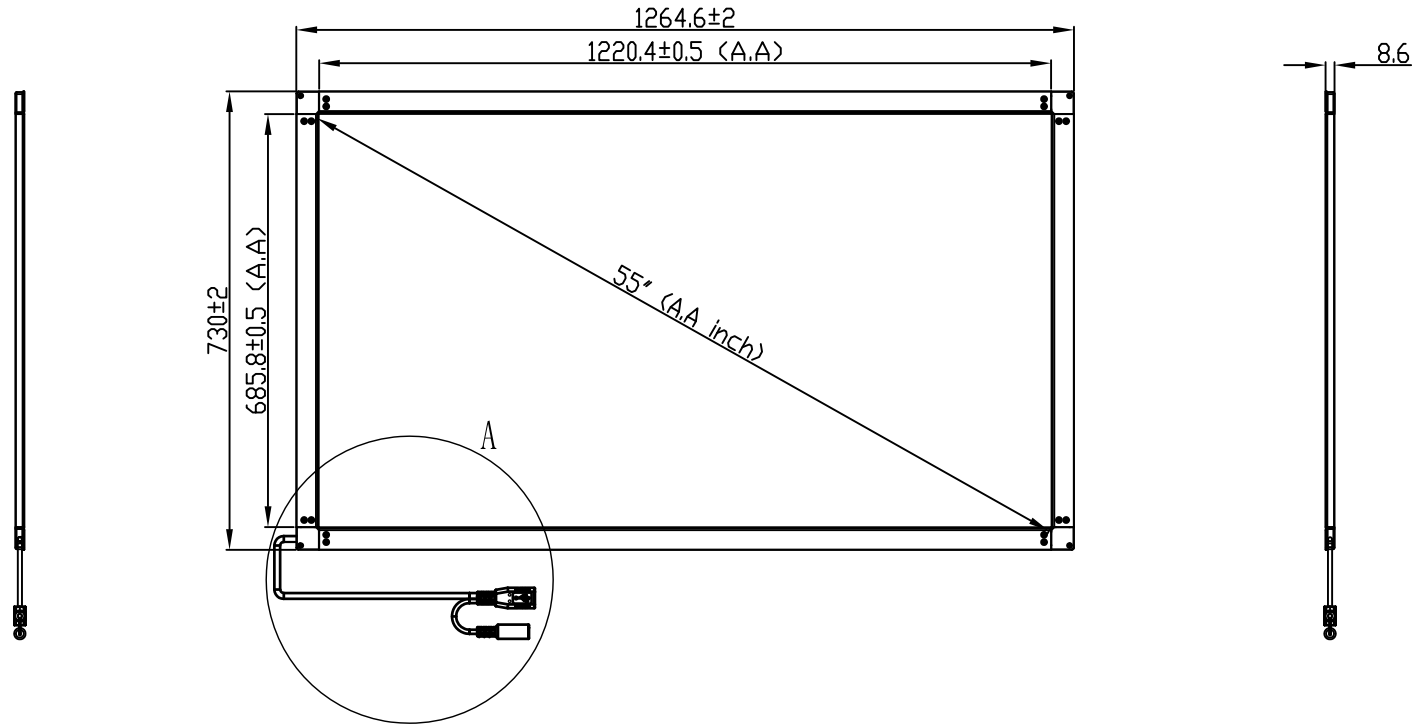

Technical Requirements:
 1. Dimensionless Units: mm;
 2. Accords with RoHS standard.

Tolerances		Pos.	Object	Material	Mass	Title
0 ~ 10 (mm)	Grade A	QTY.	Projection	Drawn	Remarks	G4 Kit V2-55" Assembly
	Grade B			Check		
10 ~ 50 (mm)	±0.3	Part No.	Type	Drawing frame	Dwg. Nr.	PQ Labs
50 ~ 100 (mm)	±0.5			Date	Nr./sheet.	
100 ~ (mm)	±1.0	The information contained herein is confidential and proprietary, and any copying redistribution of the information contained here is strictly prohibited without formal/written permission of PQ Labs Inc.				
Angle	±3.0					